

Supplemental Figure 1. Breeding Strategy

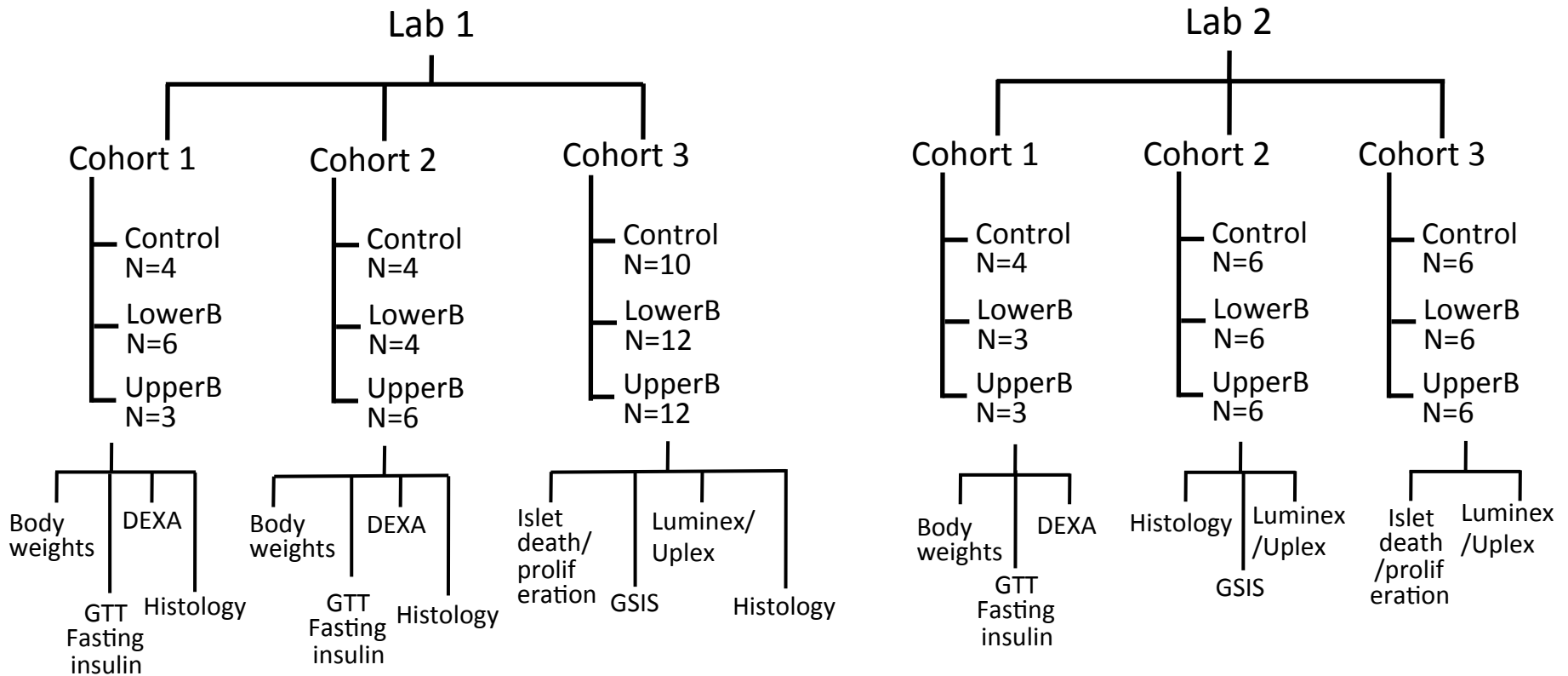

Supplemental Figure 2. Flowchart of animal usage from multiple cohorts generated in two different animal care facilities. N are number of litters. 2 to 4 male offspring and 2 to 4 female offspring per litter. GSIS: glucose stimulated insulin secretion.

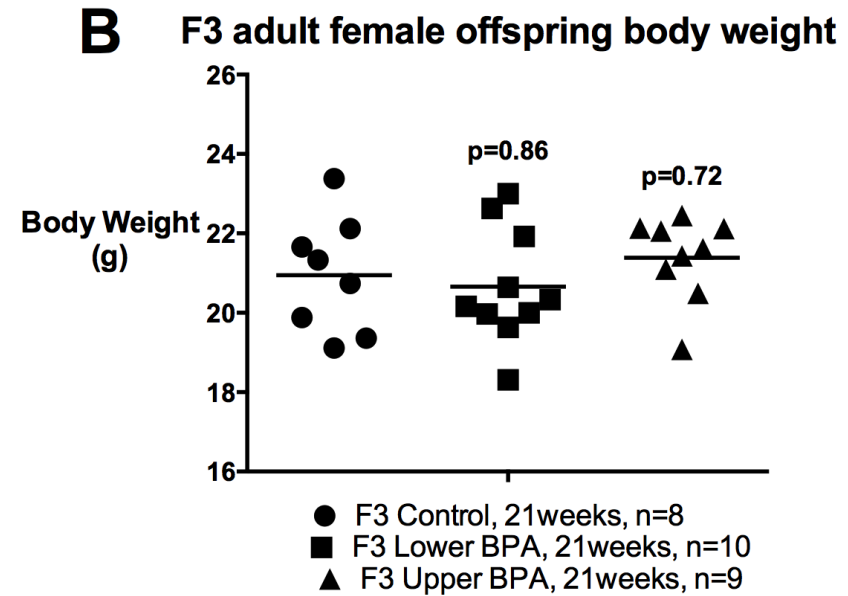
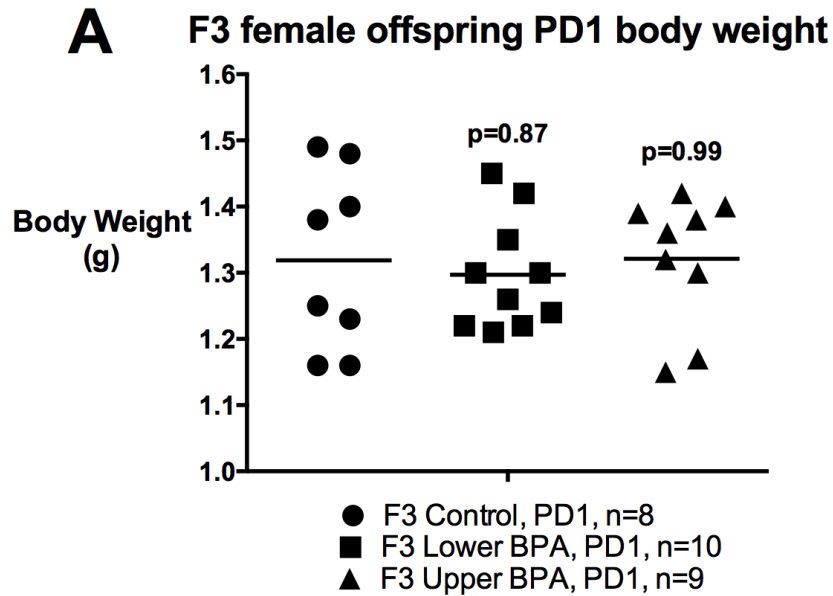

Supplemental Figure 3. Postnatal body weight of F3 female offspring. A) Postnatal day (PD) 1 body weight, and **B)** Body weight at 21 weeks of age. Data are individual litter data (n=8-10 litters per group) with mean superimposed, and analysed using Dunnett's test. P values are relative to Control.

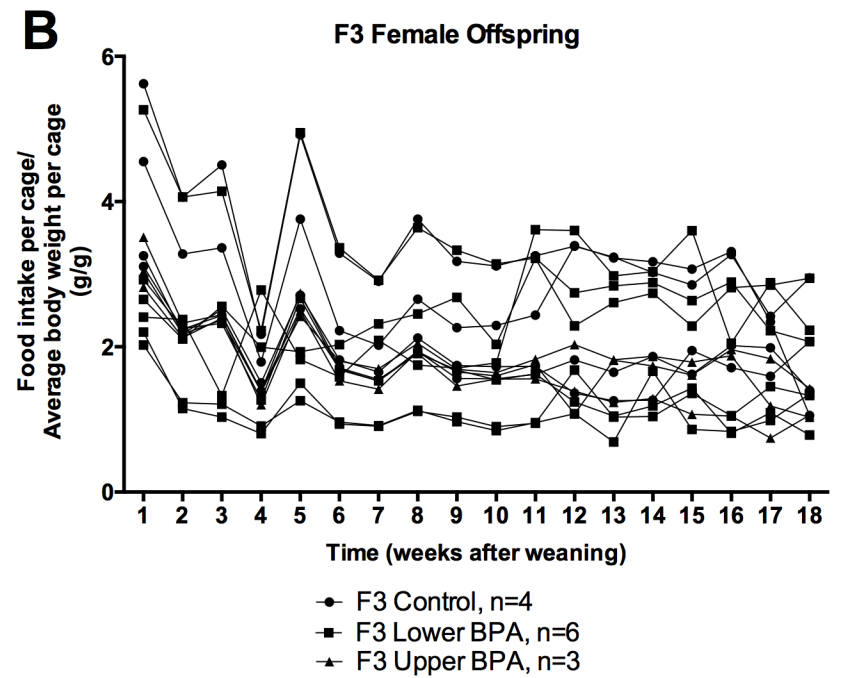
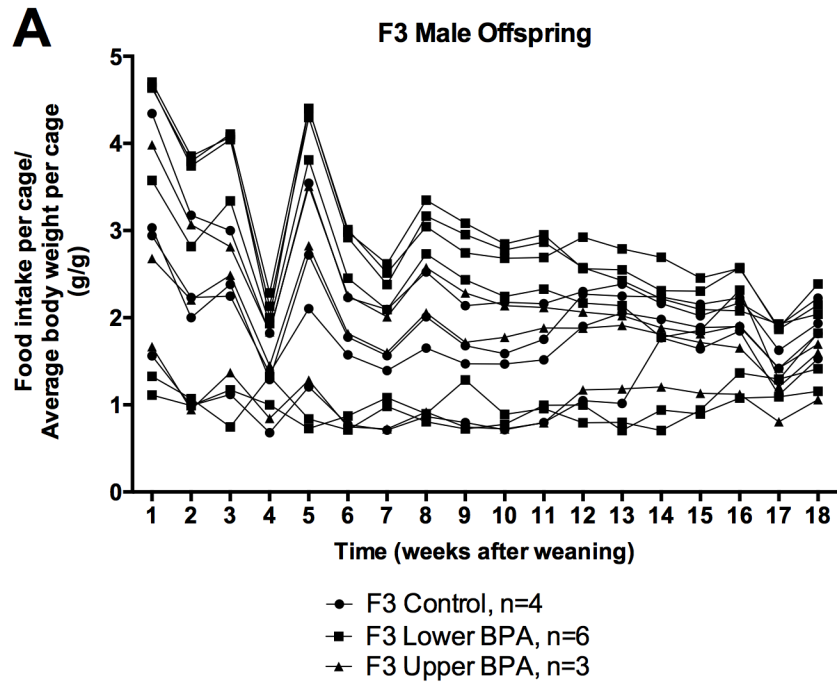

Supplemental Figure 4. Weekly food intake from weaning to 21 weeks of age. A) F3 male offspring, and B) F3 female offspring.

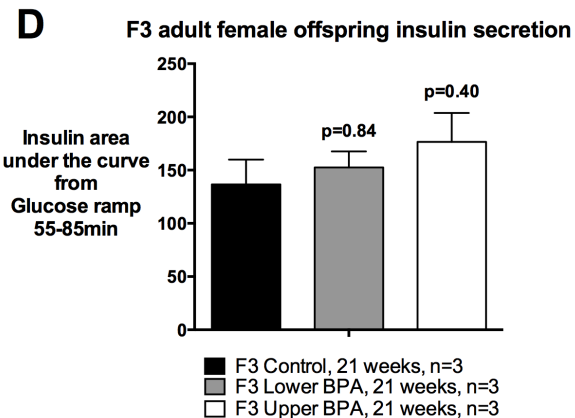
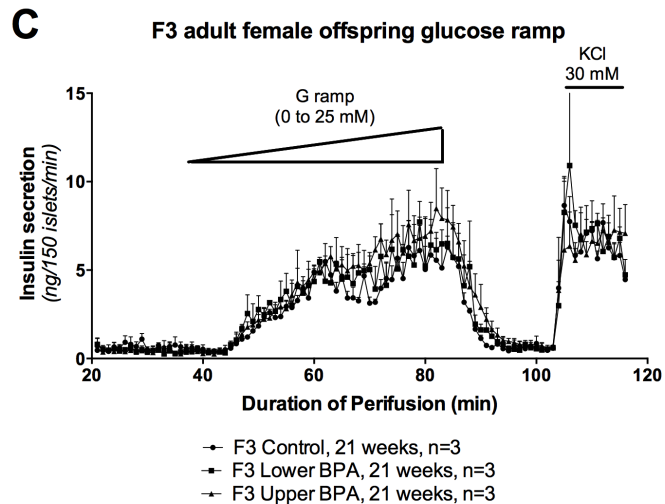
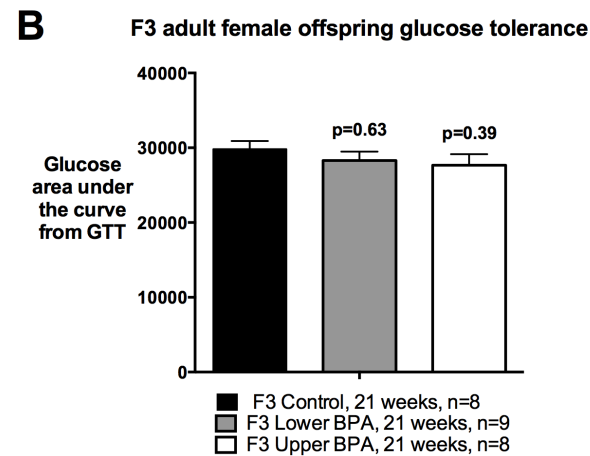
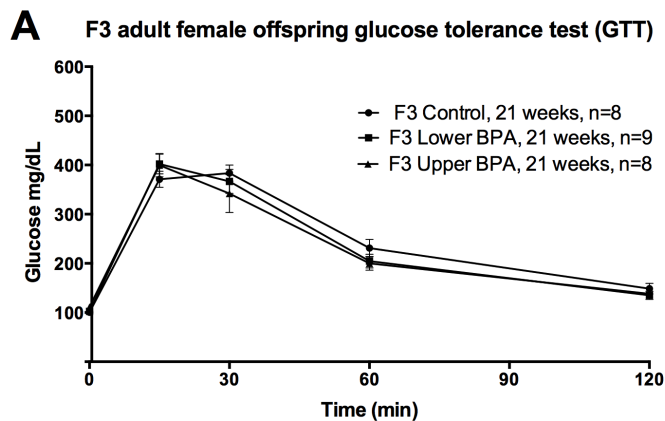

Supplemental Figure 5. Glucose tolerance test, and insulin secretion in F3 adult female offspring. **A)** Curve from glucose tolerance test, **B)** Glucose area under the curve from the glucose tolerance test, **C)** Insulin secretion on islet perfusion with increasing concentration of glucose (from 0 to 25 mM) on a glucose ramp, potassium chloride (KCl) used as a depolarizing positive control, and **D)** Glucose stimulated insulin secretion determined as insulin area under the curve from time 55 to 85 min of the glucose ramp. Data are individual litter data (one animal per litter; n=8-9 litters GTT; n=3 litters islet perfusion), and presented as mean + SEM, and analysed using Dunnett's test. P values are relative to Control.

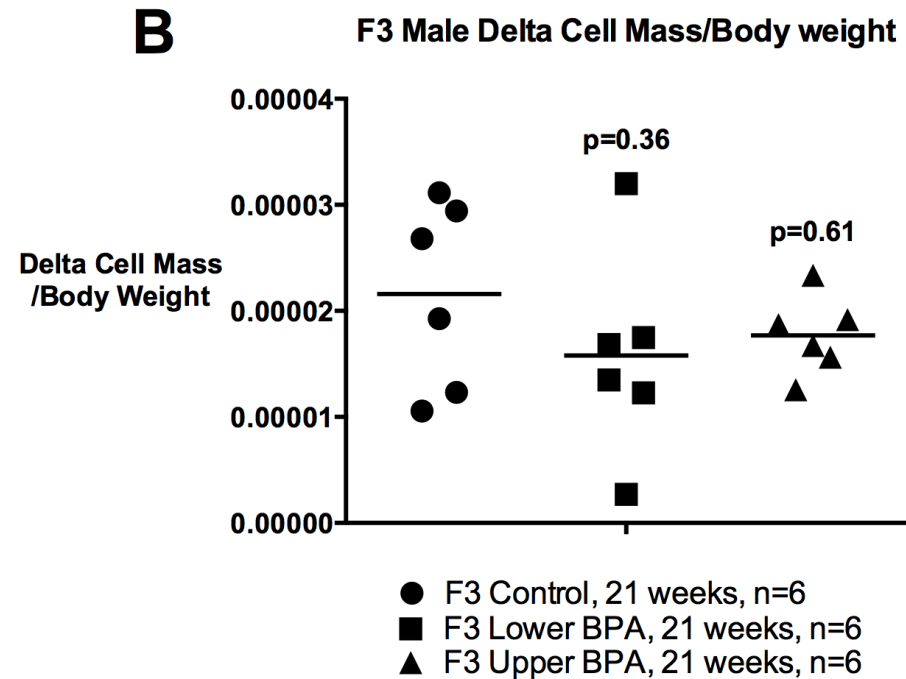
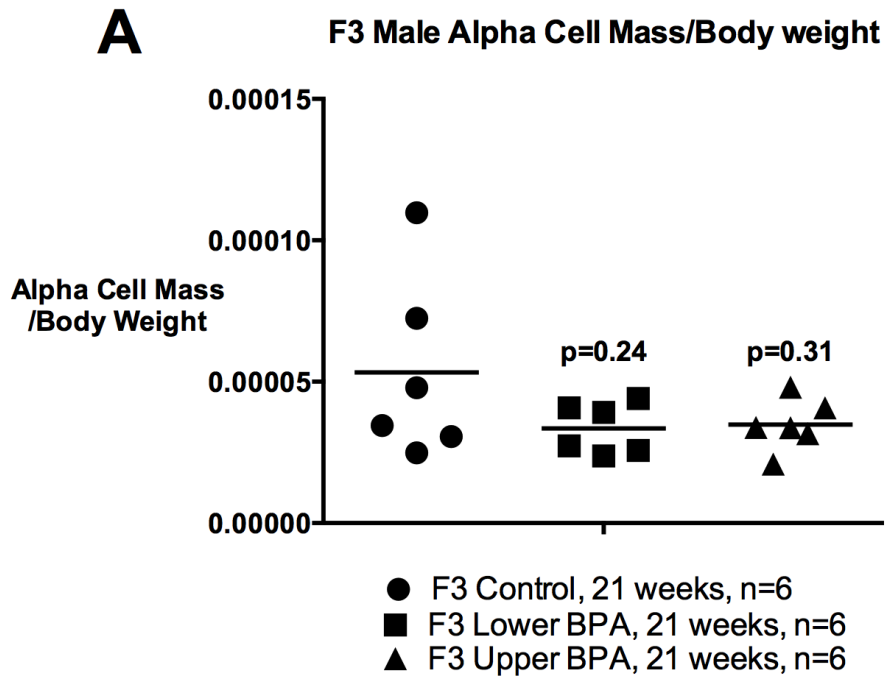

Supplemental Figure 6. Alpha and Delta mass adjusted for body weight in F3 adult male offspring: (A) Alpha cell mass adjusted for body weight, and (B) Delta cell mass adjusted for body weight. Data are individual litter data (one animal per litter) with mean superimposed. Data were log transformed where required (alpha cell mass adjusted for body weight) and analyzed using Dunnett's-test. P values are relative to Control.

Supplemental Table 1. Antibodies used for immunohistochemical and immunofluorescence staining.

Peptide/protein target	Name of Antibody	Manufacturer, catalog #, and/or name of individual providing the antibody	Species raised in; monoclonal or polyclonal	Dilution used
F4/80	Mouse F4/80	Life technologies; Cat# MF48000	Rat; monoclonal (BM8)	1:50
CD3	CD3-ε- (M-20)	Santa Cruz; Cat# sc-1127	Goat; polyclonal	1:250
Gamma Immunoglobins Heavy and Light chains	Biotinylated Anti-Goat IgG (H+L)	Vector Laboratories; Cat# BA 5000	Rabbit	1:200
Gamma Immunoglobins Heavy and Light chains	Biotinylated Anti-Rat IgG (H+L)	Vector Laboratories; Cat# BA 4001	Rabbit	1:200
Insulin	Anti-Insulin	Dako; Cat# A0564	Guinea pig; polyclonal	1:100 (PD7); 1:50 (21 weeks)
Glucagon	Anti-glucagon	BioGenex; PU039-5UP	Rabbit; polyclonal	1:50
Somatostatin	Anti-somatostatin	BioRad; Cat#8330-0009	Rat; monoclonal (YC7)	1:50
Ki67	Anti-Ki67	Abcam; Cat#ab16667	Rabbit; monoclonal (SP6)	1:50
DAPI 4',6-Diamidine-2'-phenylindole dihydrochloride	DAPI	Sigma; Cat# D9542-5MG		0.5 µg/mL
Gamma Immunoglobins Heavy and Light chains	Anti-Rabbit IgG (H+L) secondary antibody, Alexa Fluor® 488 conjugate	Life technologies; Cat# A-11034	Goat	5 µg/mL
Gamma Immunoglobins Heavy and Light chains	Anti-Guinea pig IgG (H+L) secondary antibody, Alexa Fluor® 594 conjugate	Life technologies; Cat# A-11076	Goat	5 µg/mL(PD7); 1:200 (21weeks)
Gamma Immunoglobins Heavy and Light chains	Anti-Rat IgG (H+L) secondary antibody, Alexa Fluor® 488 conjugate	Life technologies; Cat#A-11006	Goat	1:200
Gamma Immunoglobins Heavy and Light chains	Anti-Rabbit IgG (H+L) secondary antibody, Alexa Fluor® 647 conjugate	Life technologies; Cat# A-21245	Goat	1:200